

Section A-A

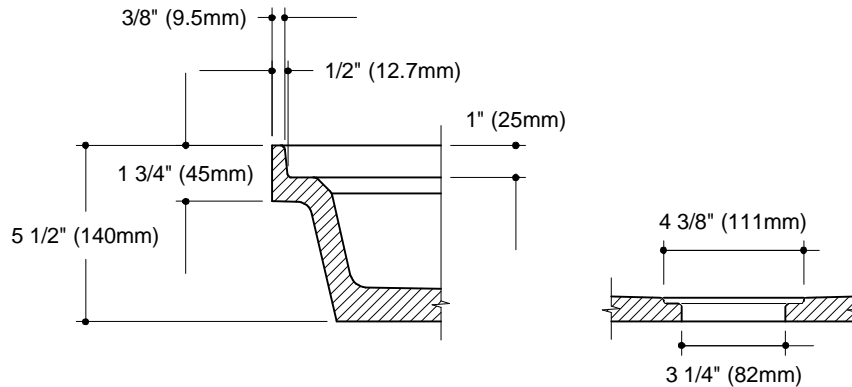

Sections showing water dam and drain details.
(Lightweight option not shown)

MOLD PART	CATALOG No.	DESCRIPTION
MALE	23061	1051-11 CORNER SHOWER 36 x 36
FEMALE	430618	F 1051-11 INSERT
TURTLE	4306181	1051-11 TURTLE
LIGHTWEIGHT FEMALE 1/2"	430619	F 1051-11 COMBO INSERT
NAME	1051-11 SHOWERPAN 36 x 36 (91cm x 91cm)	
CAST WEIGHT	SCALE 1/2" = 1' 0"	DATE 8-30-02 PAGE No. SP-24A